

 **QLICKSMART**<sup>®</sup>  
**BladeNeedleSYSTEM**  
Blade Remover | Needle Counter



Work Safe Today,

Play Safe Tomorrow.

## ▲ The forgotten sharps injury

Scalpel injuries are 200 times more likely to occur than needlestick injuries. They are particularly common in surgical settings. Regrettably, many users and clinical administrators have underestimated the likelihood of these injuries.

Scalpel cuts can happen to anyone, including you, no matter how experienced you are in handling scalpels. These cuts can result in infections, blood-borne diseases and psychological distress. Other serious injuries could require microsurgery to repair digital arteries, nerves and tendons.

Many such scalpel injuries can easily be prevented using Qlicksmart's BladeNeedleSYSTEM (BNS), the world's pioneering single-handed blade remover.



## ▲ The world's pioneering single-handed blade remover



BNS is two safety devices in one - the world's only single-handed blade remover is combined with the standard needle counter to allow an accurate count and efficient disposal of both scalpel blades and suture needles.



BNS is simple to use with a quick "push, click, and pull" action to remove and contain used scalpel blades.



This easy-to-use solution provides a low cost alternative to safety scalpels, allowing surgeons to maintain their preferences for the standard metal handle.



Used together with a hands-free passing technique, the Qlicksmart BNS can prevent up to 5 times more injuries than a safety scalpel.

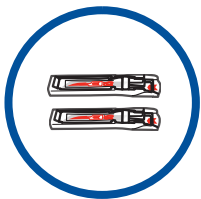

Extra blade remover cartridges are available for major surgical procedures.



It has already been embraced by healthcare workers around the world for its unique dual function, cost-saving and ease of inclusion into custom procedure packs.



The BNS contains the features of a numbered foam block for needles, a magnetic surface to hold odd-shaped sharps, and Qlicksmart's single-handed blade remover to remove used scalpel blades.

**Workplace safety is the right of all healthcare workers, and the responsibility of all employers. Use the Qlicksmart BladeNeedleSYSTEM and be safe.**

# Specifications

Product code	QBNS202S	
GMDN code	46236	
Blade capacity	2 cartridges in the unit - each cartridge removes 1 (one) blade.	
Compatible Blades & Handles*	Handles: #3, 3L, 4, 4L, 5, 7, 9, baron, cylindrical. Blades: #10, 10a, 11, 11P, 12, 14, 15, 15a, 15c, 16, 19, 20, 21, 22, 22a, 23, 24, 25, 25a, 27, 36, 6, 9, E11, Sabre D/15.	
Incompatible Blades & Handles	Beaver handle, Disposable handles	
Size (per unit)	Closed: Length 11.7cm Width 6.6cm Height 3.9cm	Open**: Length 11.7cm Width 12.7cm Height 8.7cm
Weight (per unit)	51g	

Material	Needle counter box: High Impact Polystyrene Cartridges: Polypropylene (PP)
Latex	No
DEHP	No
Sterile	Yes
Sterilisation method	Gamma radiation
Re-usable	No, each cartridge removes 1 (one) blade before disposal.
Disposal method	After the blade and needle counts have been performed, the needle counter and cartridges are disposed of separately as medical wastes in a sharps container.
Regulatory approvals	Australia - Listed under TGAARTG NO: 208058 USA - FDA listed Europe - Class I Sterile medical device under Council Directive 93/42/EEC and CE marked

\* Most brands will work with Qlicksmart BladeNeedleSYSTEM.

\*\* Open box with cartridge standing in the holder

## How to use BladeNeedleSYSTEM

## BladeNeedleSYSTEM

Blade Remover | Needle Counter

### PREPARE USING TWO HANDS:

1. Peel the double sided tapes, open and stick the BNS down.

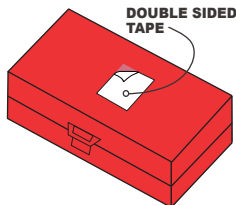

DOUBLE SIDED TAPE



2. To remove a used scalpel blade, take a cartridge and place it inside the round holder.

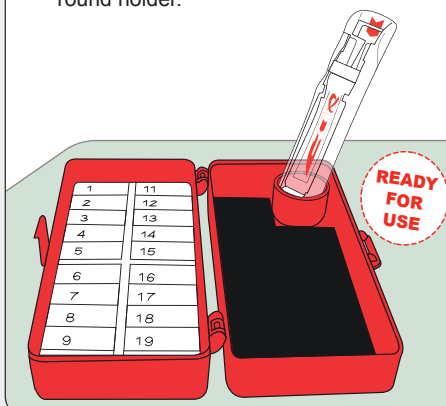

READY FOR USE

### ACTIVATE SINGLE HANDED:

3. Using one hand, slide tip of scalpel into cartridge.

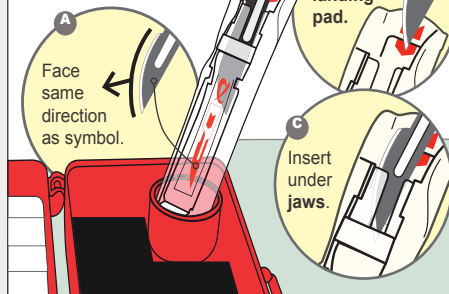

4. TILT UP to 90° then push down.

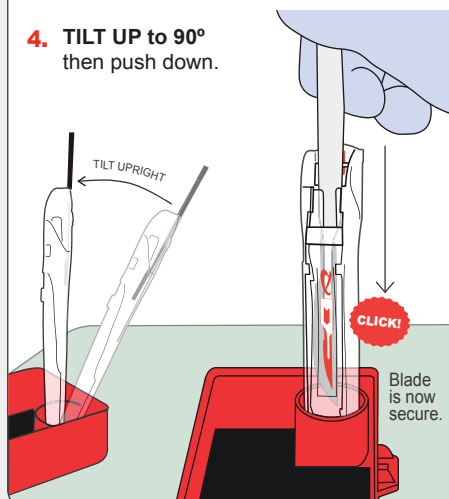

CLICK!  
Blade is now secure.

5. Remove cartridge from the round holder.

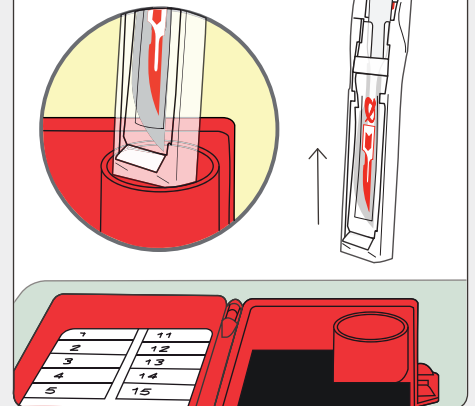

### SAFE TO USE TWO HANDS:

6. Pull out scalpel handle.

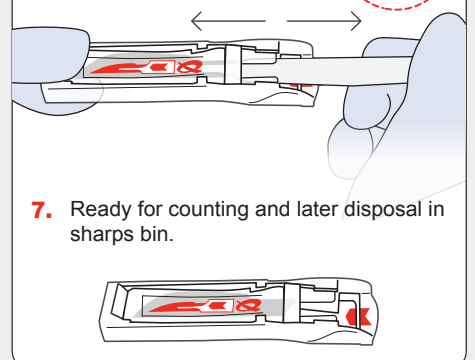

7. Ready for counting and later disposal in sharps bin.

## Qlicksmart Pty. Ltd.



Level 1, 148 Boundary Street,  
West End, Brisbane,  
QLD 4101, Australia



+61-7-3844-1182



+61-7-3844-1183



[www.qlicksmart.com](http://www.qlicksmart.com)



[mjs@qlicksmart.com](mailto:mjs@qlicksmart.com)

Distributed by:



Stay Connected

